

CLAPTON Chair/Armchair

Michele Mantovani. Caryn Donovan. 2016



CLAPTON Chair/Armchair

Michele Mantovani. Caryn Donovan. 2016



Contraste de lleno y vacío para un perfecto rigor volumétrico. Madera, Tela o Piel. Bastidor en madera maciza con formas orgánicas. Estructura de madera maciza. Asiento y Respaldo continuos. Tapizados siguiendo las líneas redondeadas del bastidor tapizados en Goma espuma JBS de 35Kg y forrado en gomaespuma de 15m/m.

CLAPTON Chair
84x55x55cm

Chair
Ref/19.097 - 19.098

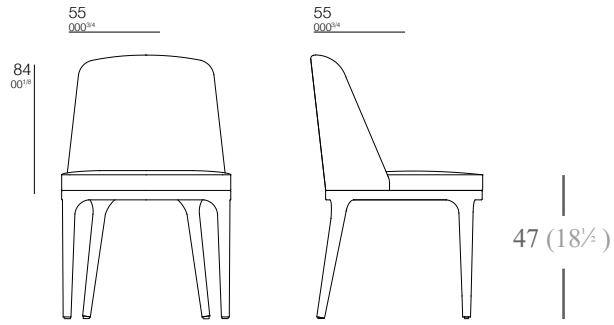

Acabado / Finish: Roble / Oak		
H:84 L:55 F:55 (Vol. 0,36 m ³)		
H:33 1/4 L:21 1/4 F:21 1/4		
Ref	Tela / Fabric	Puntos / Points
19.097/TC	Tela Cliente C.O.M.	69
19.097/A	CAT. A	73
19.097/B	CAT. B	76
19.097/C	CAT. C	79
19.097/D	CAT. D	83
19.097/E	CAT. E	91
19.097/P1	P1	89
19.097/P2	P2	98

Acabado / Finish: Nogal / Walnut		
H:84 L:55 F:55 (Vol. 0,36 m ³)		
H:33 1/4 L:21 1/4 F:21 1/4		
Ref	Tela / Fabric	Puntos / Points
19.098/TC	Tela Cliente C.O.M.	78
19.098/A	CAT. A	82
19.098/B	CAT. B	85
19.098/C	CAT. C	88
19.098/D	CAT. D	92
19.098/E	CAT. E	100
19.098/P1	P1	98
19.098/P2	P2	107

Metraje/ Length: 1,10 m ancho tela/ width fabric 1,40
2,00 m² Piel

CLAPTON Armchair
75,7x73x71cm

Armchair
Ref/19.039 - 19.038

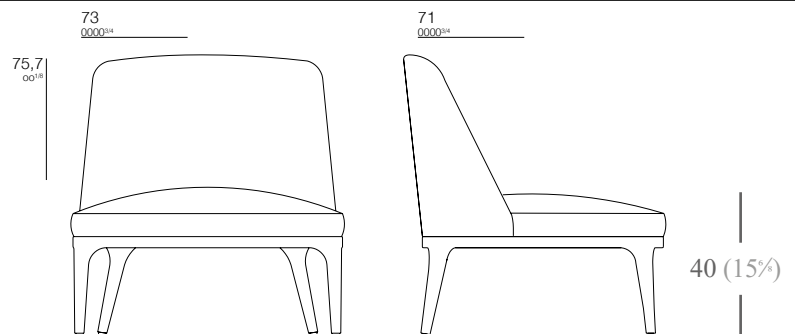

Acabado / Finish: Roble / Oak		
H:75,7 L:73 F:71 (Vol. 0,54 m ³)		
H:31 1/4 L:35 1/4 F:41 1/4		
Ref	Tela / Fabric	Puntos / Points
19.039/TC	Tela Cliente C.O.M.	140
19.039/A	CAT. A	150
19.039/B	CAT. B	154
19.039/C	CAT. C	160
19.039/D	CAT. D	169
19.039/E	CAT. E	186
19.039/P1	P1	194
19.039/P2	P2	222

Acabado / Finish: Nogal / Walnut		
H:75,7 L:73 F:71 (Vol. 0,54 m ³)		
H:31 1/4 L:35 1/4 F:41 1/4		
Ref	Tela / Fabric	Puntos / Points
19.038/TC	Tela Cliente C.O.M.	154
19.038/A	CAT. A	165
19.038/B	CAT. B	169
19.038/C	CAT. C	176
19.038/D	CAT. D	186
19.038/E	CAT. E	204
19.038/P1	P1	213
19.038/P2	P2	244

Cojín Clapton
Clapton Cushion

30x18 (11 1/4 x 7 1/4)		
Tela / Fabric	Ref	Puntos / Points
Tela Cliente C.O.M.	19.138/TC	5
CAT. A	19.138/A	6
CAT. B	19.138/B	7
CAT. C	19.138/C	7
CAT. D	19.138/D	8
CAT. E	19.138/E	10
P1	19.138/P1	9
P2	19.138/P2	10

Metraje/ Length: 2,05 m ancho tela/ width fabric 1,40
3,50 m² Piel

INTERIVISION Acabados/ Finishes

Madera/ Wood



Roble Blanco Pluma



Roble Gris Norte



Roble Café



Roble Marrón Volcánico



Roble Negro Noche



Raiz de Roble
Blanco Cálido



Raiz de Roble
Gris Norte



Raiz de Roble
Café



Raiz de Roble
Marrón Volcánico

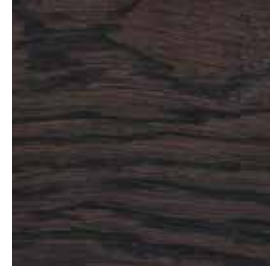

Raiz de Roble
Negro Noche



Nogal Claro



Nogal Oscuro

Lacado/ Lacquered



Beig Claro

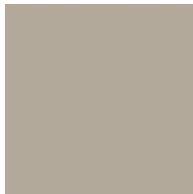

Beig Claro Brillo

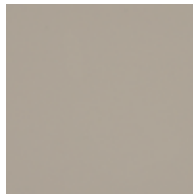

Beig Claro Mate

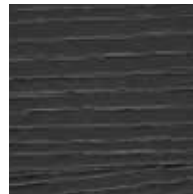

Negro Pizarra



Negro Pizarra Brillo



Negro Pizarra Mate



Cobalto Claro

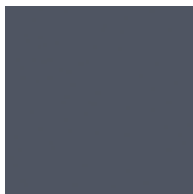

Cobalto Brillo

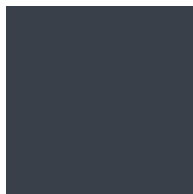

Cobalto Mate



Tierra



Tierra Brillo



Tierra Mate



Marrón Pizarra

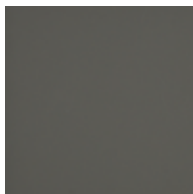

Marrón Pizarra Brillo

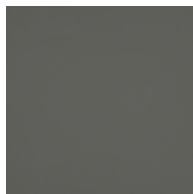

Marrón Pizarra Mate



Mostaza



Mostaza Brillo



Mostaza Mate

Metales/ Metals

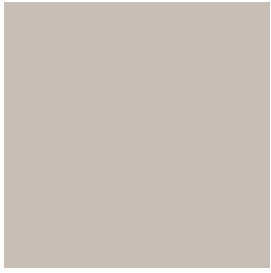

Acero Brillo



Acero Patinado



Cobre Negro



Latón Antiguo

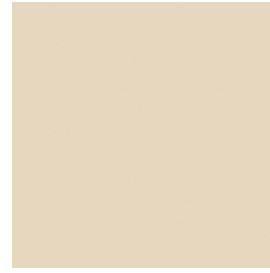

Latón Brillo



Latón Mate



Latón Rosa

Piedras/ Stones



Marmol Blanco Macael



Marmol Blanco Luzinda

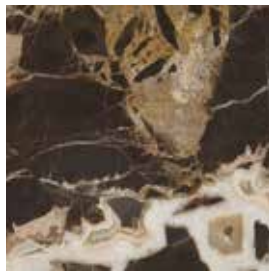

Marmol Emperador Gold



Marmol Negro Marquina

Espejos/ Mirrors



Bronce



Gris