

THE
ILAND
COLLECTION

by Fermín Verdeguer

MOBILFRESNO

ILAND TECHNIC PRICE LIST

by Fermín Verdeguer

FINISHES / ACABADOS / FINITIONS

| VENEERS CHAPAS / BOIS | LACQUERS LACQUERS / LAQUÉS | MIRRORS ESPEJOS / MIROIRS | METALS METALES | MARBLE MÁRMOLES / MARBRE |
|--|--|--|---|--|
| Ash Burl Gris Matt Ash Burl Gris Gloss Ash Burl Cherry Matt Ash Burl Cherry Gloss Ash Burl Embero Matt Ash Burl Embero Gloss European Walnut Matt European Walnut Gloss | Blanco Metalizado Arena Metalizado Oro Viejo Metalizado Óxido Metalizado Esmeralda Metalizado Pizarra Metalizado Carbón Metalizado Negro Metalizado | Grey Mirror Bronze Mirror Espejo Gris Espejo Bronce Miroir Gris Miroir Bronze | Metal accents in brass Las piezas metálicas son de latón Les parties métalliques sont fabriquée en laiton | Onix Blanco Mate (Grosor 2cm) Matt (thickness 2cm) / Matt (épaisseur 2cm) Onix Blanco Brillo (Grosor 2cm) Gloss (thickness 2cm) / Brillant (épaisseur 2cm) Negro Intenso (Grosor 3cm) (thickness 3cm) / (épaisseur 3cm) Emperador Gold Mate (Grosor 3cm) (thickness 3cm) / (épaisseur 3cm) Emperador Gold Brillo (Grosor 3cm) (thickness 3cm) / (épaisseur 3cm) Rainforest (Grosor 2cm) (thickness 2cm) / (épaisseur 2cm) |

Hi - Gloss option: 5% upcharge (Except mirrors and chairs)

Opción Brillo: incremento 5% sobre los Puntos indicados en la tarifa (Excepto espejo y sillas)

Option brillant: 5% supplement (Sauf miroirs et chaises)

| Eng | Spa | Fra |
|---------------------------|---------------------------------|---------------------------|
| Walnut | Nogal | Noyer |
| Lacquer | Laca | Laqué |
| Ash Burl | Lupa de Fresno | Loupe de Frêne |
| Lacquered Metallic Pieces | Piezas Metálicas en Laca | Pieces Metalliques Laqués |
| Backlight Upcharge | Incremento por Retroiluminación | Supplement Eclairage |
| Fabric | Tela | Tissú |
| C.O.M | Tela Cliente | Tissú Client |
| Leather | Piel | Cuir |
| Fabric Required | Metraje | Tissu Nécessaire |

Due to the use of natural materials, finish can be slightly different from the sample.

Debido a la utilización de materias primas naturales, el acabado puede variar ligeramente respecto a las muestras.

On travail avec produits naturels, alors il peut y avoir changements par rapport aux echantillons.

Valid prices except for printing mistakes. The company reserves the right to revise and/or modify this pricelist without previous advice.

Precios válidos excepto error tipográfico. La empresa se reserva el derecho a la modificación de esta tarifa sin previo aviso.

Prix valables sauf erreur typographique, nous pouvons changer la tarif de prix sans notification.

SIDEBBOARD TOKIO / APARADOR TOKIO / BUFFET TOKIO

Sideboard Tokio / Aparador Tokio / Buffet Tokio

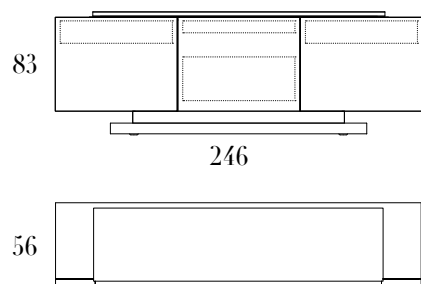

| Finish | Ref | Points Brass |
|--------------------|--------|--------------|
| Walnut | 18.000 | 1.322 |
| Walnut / Lacquer | 18.001 | 1.322 |
| Ash Burl / Lacquer | 18.002 | 1.598 |
| Lacquer | 18.003 | 1.152 |

Small Sideboard Tokio / Aparador Tokio Pequeño / Buffet Petit Tokio

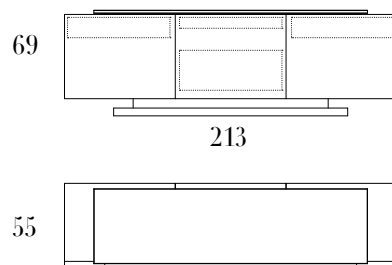

| Finish | Ref | Points Brass |
|--------------------|--------|--------------|
| Walnut | 18.004 | 1.216 |
| Walnut / Lacquer | 18.005 | 1.216 |
| Ash Burl / Lacquer | 18.006 | 1.468 |
| Lacquer | 18.007 | 1.060 |

| Marble Mármoles / Marbre | Upcharge Incremento / Augmenter |
|-----------------------------|------------------------------------|
| Onix Blanco | +44 |
| Negro Intenso | +112 |
| Rainforest | +35 |

Points option with Marble Emperador Gold. For different marble option, please check upcharge in chart on the right. Drawers upholstered in leather.
 Puntos para muebles con tapa Mármol Emperador Gold. Para otros mármoles consultar incremento en la tabla de la derecha. Cajones tapizados en piel.
 Points avec plateau Marbre Emperador Gold. Voir supplement pour autres marbres. Interieures tiroirs en cuir.

INTERIOR DISTRIBUTION FOR DRAWERS TOKIO / DISTRIBUCIÓN INTERIOR PARA CAJONES TOKIO / DISTRIBUTION INTÉRIEURE TIROIRS TOKIO

Top Drawer
Cajón Superior
Tiroir Supérieur

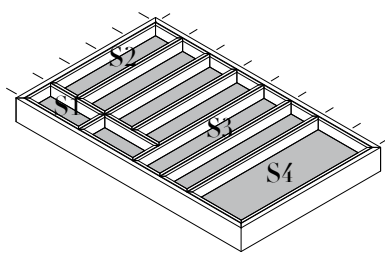

Distribution for Top Drawer
Distribución para Cajón Superior
Distribution pour Tiroir Supérieur

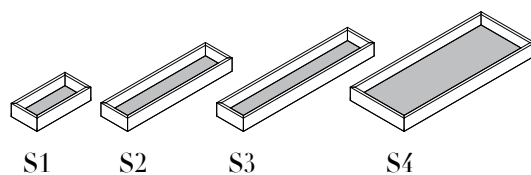

| | Points |
|---|-----------|
| Interior distribution as sketch Distribución Interior del Esquema Distribution interieure selon croquis | 58 |

| Part | Lacquer | Walnut | Points |
|------|---------|--------|-----------|
| S1 | 18.010 | 18.014 | 4 |
| S2 | 18.011 | 18.015 | 6 |
| S3 | 18.012 | 18.016 | 8 |
| S4 | 18.013 | 18.017 | 10 |

Bottom Drawer
Cajón Inferior
Tiroir Inférieur

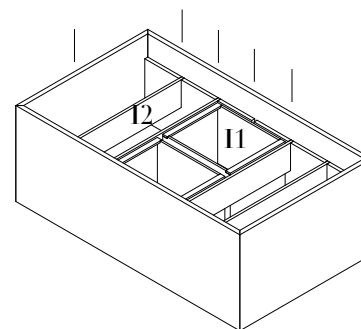

Distribution for Bottom Drawer
Distribución para Cajón Inferior
Distribution pour Tiroir Inférieur

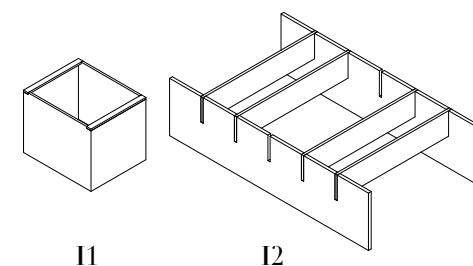

| | Points |
|---|-----------|
| Interior distribution as sketch Distribución Interior del Esquema Distribution interieure selon croquis | 42 |

| Part | Lacquer | Walnut | Points |
|------|---------|--------|-----------|
| I1 | 18.018 | 18.019 | 24 |
| I2 | 18.026 | 18.027 | 18 |

SHOWCASES MOONLIGHT / VITRINAS MOONLIGHT / VITRINES MOONLIGHT

COSMÓPOLIS COCTAIL UNIT / MUEBLE BAR / MEUBLE BAR

Interior with Shelves
Interior Estantes
Intérieur avec Étagères

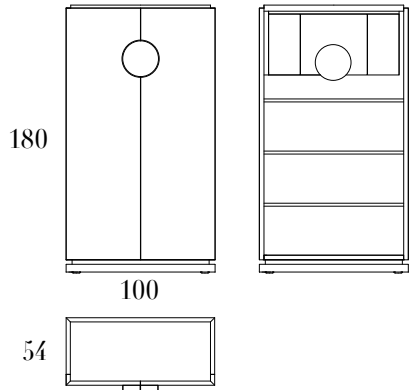

Interior with Drawers
Interior Cajones
Intérieur avec Tiroirs

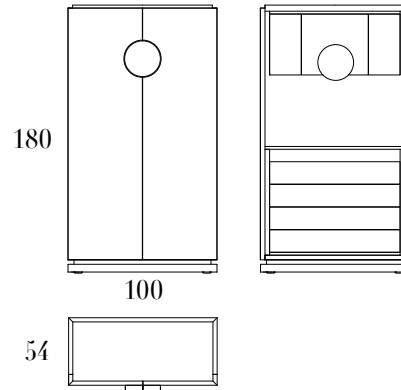

| Finish | Ref | Points Brass |
|--------------------|--------|--------------|
| Walnut / Lacquer | 18.020 | 1.464 |
| Ash Burl / Lacquer | 18.021 | 1.758 |
| Lacquer | 18.022 | 1.366 |

| Finish | Ref | Points Brass |
|--------------------|--------|--------------|
| Walnut / Lacquer | 18.023 | 1.556 |
| Ash Burl / Lacquer | 18.024 | 1.845 |
| Lacquer | 18.025 | 1.448 |

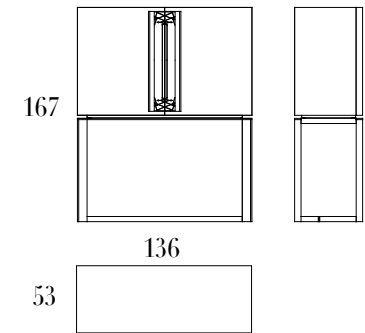

| Finish | Ref | Points Brass |
|--------------------|--------|--------------|
| Walnut / Lacquer | 18.100 | 1.748 |
| Ash Burl / Lacquer | 18.101 | 2.061 |
| Lacquer | 18.102 | 1.662 |

Upholstered back panel, marble and backlight include.
Trasera tapizada, mármol e iluminación incluidos.
Doss rembourrés, marbre et éclairages inclus.

Upholstered backpanel and drawers, marble and backlight include.
Trasera y cajones tapizados, mármol e iluminación incluidos.
Doss et tiroir rembourrés, marbre et éclairages inclus.

MIRRORS NARCISO / ESPEJOS NARCISO / MIROIRS NARCISO

Espejo Redondo
Rounded Mirror
Miroir Rond

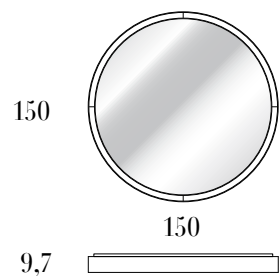

Square Mirror
Espejo Cuadrado
Miroir Carré

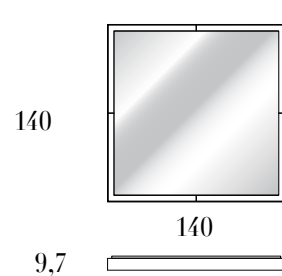

Rectangular Mirror
Espejo Rectangular
Miroir Rectangulaire

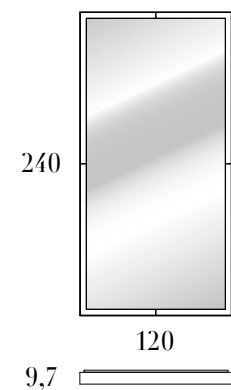

| Finish | Ref | Points Brass |
|--------------------|--------|--------------|
| Walnut | 18.030 | 476 |
| Ash Burl | 18.031 | 505 |
| Lacquer | 18.032 | 446 |
| Backlight Upcharge | | +91 |

| Finish | Ref | Points Brass |
|--------------------|--------|--------------|
| Walnut | 18.033 | 456 |
| Ash Burl | 18.034 | 479 |
| Lacquer | 18.035 | 431 |
| Backlight Upcharge | | +86 |

| Finish | Ref | Points Brass |
|--------------------|--------|--------------|
| Walnut | 18.036 | 535 |
| Ash Burl | 18.037 | 560 |
| Lacquer | 18.038 | 511 |
| Backlight Upcharge | | +102 |

TABLES / MESAS

Rectangular Table Stonefly
Mesa Rectangular Stonefly
Table Rectangulaire Stonefly

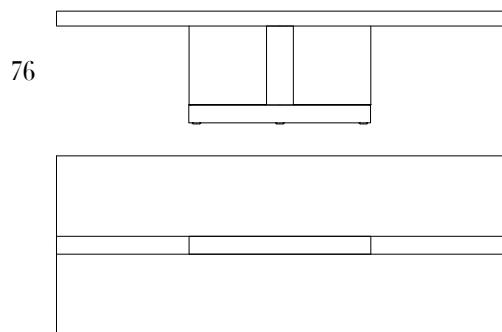

| H:76 L:300 F:120 | | |
|------------------|--------|--------------|
| Finish | Ref | Points Brass |
| Walnut | 18.040 | 970 |
| Ash Burl | 18.041 | 1.244 |
| Lacquer | 18.042 | 792 |
| H:76 L:250 F:110 | | |
| Walnut | 18.043 | 858 |
| Ash Burl | 18.044 | 1.050 |
| Lacquer | 18.045 | 716 |
| H:76 L:220 F:110 | | |
| Walnut | 18.046 | 800 |
| Ash Burl | 18.047 | 1.005 |
| Lacquer | 18.048 | 669 |

Square Table Stonefly
Mesa Cuadrada Stonefly
Table Carré Stonefly

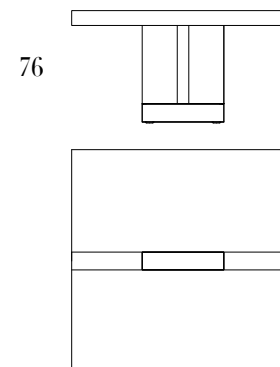

| H:76 L:160 F:160 | | |
|------------------|--------|--------------|
| Finish | Ref | Points Brass |
| Walnut | 18.050 | 797 |
| Ash Burl | 18.051 | 1.018 |
| Lacquer | 18.052 | 672 |
| H:76 L:150 F:150 | | |
| Walnut | 18.053 | 777 |
| Ash Burl | 18.054 | 978 |
| Lacquer | 18.055 | 658 |

Desk Delta
Escritorio Delta
Bureau Delta

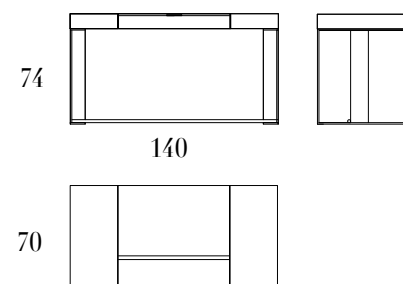

| Finish | Ref | Points Brass |
|--------------------|--------|--------------|
| Walnut | 18.060 | 1.157 |
| Ash Burl | 18.061 | 1.210 |
| Lacquer | 18.062 | 1.099 |
| Walnut / Lacquer | 18.063 | 1.151 |
| Ash Burl / Lacquer | 18.064 | 1.202 |

CHAIR CALAS / SILLA CALAS / CHAISES CALAS

Metal Legs / Patas Metálicas / Pieds Metalliques

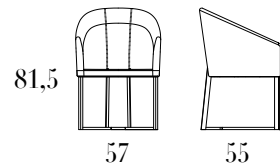

| Upholstered / Tapizado / Tapissé | Ref | Points Brass |
|----------------------------------|-----------|--------------|
| C.O.M. | 18.066/TC | 148 |
| Fabric B | 18.066/B | 158 |
| Fabric C | 18.066/C | 163 |
| Fabric D | 18.066/D | 169 |
| Fabric E | 18.066/E | 182 |
| Fabric F | 18.066/F | 209 |
| Fabric G | 18.066/G | 242 |
| Leather 1 | 18.066/P1 | 170 |
| Leather 2 | 18.066/P2 | 185 |
| Leather Special | 18.066/PE | 205 |

Fabric Required: 1,90 m Fabric Width 1,40m
2,50 m² Leather

Wooden Legs / Patas de Madera / Pieds Bois

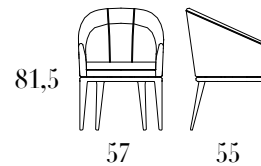

| Upholstered / Tapizado / Tapissé | Ref | Points Brass |
|----------------------------------|-----------|--------------|
| C.O.M. | 18.106/TC | 108 |
| Fabric B | 18.106/B | 118 |
| Fabric C | 18.106/C | 123 |
| Fabric D | 18.106/D | 129 |
| Fabric E | 18.106/E | 142 |
| Fabric F | 18.106/F | 169 |
| Fabric G | 18.106/G | 202 |
| Leather 1 | 18.106/P1 | 130 |
| Leather 2 | 18.106/P2 | 145 |
| Leather Special | 18.106/PE | 165 |

Fabric Required: 1,90 m Fabric Width 1,40m
2,50 m² Leather

Armchair Calas / Butaca Calas / Fauteuil Calas

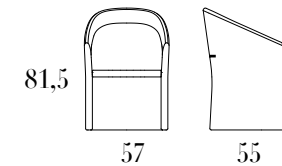

| Upholstered / Tapizado / Tapissé | Ref | Points |
|----------------------------------|-----------|------------|
| C.O.M. | 18.067/TC | 101 |
| Fabric B | 18.067/B | 119 |
| Fabric C | 18.067/C | 126 |
| Fabric D | 18.067/D | 137 |
| Fabric E | 18.067/E | 159 |
| Fabric F | 18.067/F | 204 |
| Fabric G | 18.067/G | 259 |
| Leather 1 | 18.067/P1 | 175 |
| Leather 2 | 18.067/P2 | 191 |
| Leather Special | 18.067/PE | 228 |

Fabric Required: 2,50 m Fabric Width 1,40m
4,50 m² Leather

KILIMA COFFEE TABLES / MESAS DE CENTRO KILIMA / TABLES BASSES KILIMA

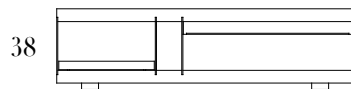

140

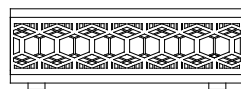

110

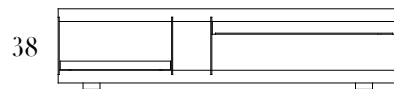
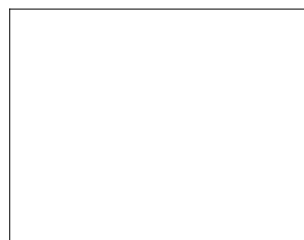

160

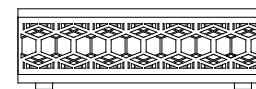

119



| Finish | Ref | Points Brass |
|----------|--------|--------------|
| Walnut | 18.110 | 875 |
| Ash Burl | 18.111 | 974 |
| Lacquer | 18.112 | 789 |

| Finish | Ref | Points Brass |
|----------|--------|--------------|
| Walnut | 18.113 | 998 |
| Ash Burl | 18.114 | 1.110 |
| Lacquer | 18.115 | 898 |

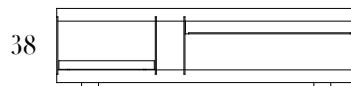

141

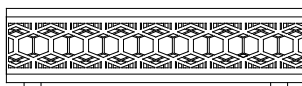

141



| Finish | Ref | Points Brass |
|----------|--------|--------------|
| Walnut | 18.116 | 1.089 |
| Ash Burl | 18.117 | 1.208 |
| Lacquer | 18.118 | 980 |

KILIMA CUBE

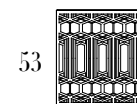

53

50



50

| Ref | Points Brass |
|--------|--------------|
| 18.119 | 442 |

TWIN COFFEE TABLES / MESAS CENTRO TWIN / TABLES BASSES TWIN

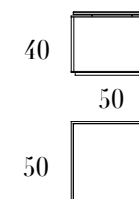
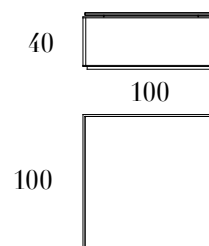
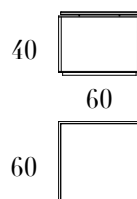
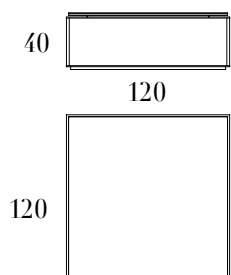

| Top | Ref | Points |
|-----------------------|--------|------------|
| Marble Negro Intenso | 18.121 | 490 |
| Marble Onix | 18.122 | 462 |
| Marble Emperador Gold | 18.123 | 346 |
| Marble Rainforest | 18.124 | 445 |
| Lacquered Metal | 18.125 | 336 |
| Brass | 18.126 | 646 |
| Walnut | 18.127 | 287 |
| Ash Burl | 18.128 | 314 |

| Top | Ref | Points |
|-----------------------|--------|------------|
| Marble Negro Intenso | 18.131 | 176 |
| Marble Onix | 18.132 | 170 |
| Marble Emperador Gold | 18.133 | 141 |
| Marble Rainforest | 18.134 | 161 |
| Lacquered Metal | 18.135 | 143 |
| Brass | 18.136 | 238 |
| Walnut | 18.137 | 132 |
| Ash Burl | 18.138 | 139 |

| Top | Ref | Points |
|-----------------------|--------|------------|
| Marble Negro Intenso | 18.141 | 382 |
| Marble Onix | 18.142 | 363 |
| Marble Emperador Gold | 18.143 | 283 |
| Marble Rainforest | 18.144 | 351 |
| Lacquered Metal | 18.145 | 276 |
| Brass | 18.146 | 512 |
| Walnut | 18.147 | 242 |
| Ash Burl | 18.148 | 261 |

| Top | Ref | Points |
|-----------------------|--------|------------|
| Marble Negro Intenso | 18.151 | 144 |
| Marble Onix | 18.152 | 140 |
| Marble Emperador Gold | 18.153 | 120 |
| Marble Rainforest | 18.154 | 136 |
| Lacquered Metal | 18.155 | 124 |
| Brass | 18.156 | 192 |
| Walnut | 18.157 | 115 |
| Ash Burl | 18.158 | 129 |

TWIN AUXILIAR TABLES / MESAS AUXILIARES TWIN

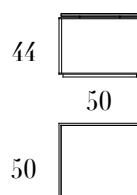
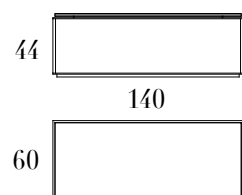

| Top | Ref | Points |
|-----------------------|--------|------------|
| Marble Negro Intenso | 18.161 | 344 |
| Marble Onix | 18.162 | 328 |
| Marble Emperador Gold | 18.163 | 260 |
| Marble Rainforest | 18.164 | 318 |
| Lacquered Metal | 18.165 | 258 |
| Brass | 18.166 | 460 |
| Walnut | 18.167 | 227 |
| Ash Burl | 18.168 | 242 |

| Top | Ref | Points |
|-----------------------|--------|------------|
| Marble Negro Intenso | 18.171 | 144 |
| Marble Onix | 18.172 | 140 |
| Marble Emperador Gold | 18.173 | 120 |
| Marble Rainforest | 18.174 | 136 |
| Lacquered Metal | 18.175 | 124 |
| Brass | 18.176 | 192 |
| Walnut | 18.177 | 115 |
| Ash Burl | 18.178 | 123 |

Structures always be lacquered
Las estructuras siempre irán lacadas
Structures toujours laqués

/ Marble top thickness 2 cm
/ Tapas de mármol grosor 2 cm
/ Plateaux marbre épaisseur 2 cm

TWIN PEDESTALS / PEDESTALES TWIN / PIEDESTALS TWIN

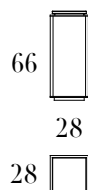
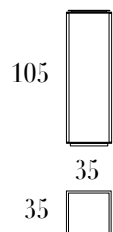

| Top | Ref | Points |
|-----------------------|--------|------------|
| Marble Negro Intenso | 18.181 | 104 |
| Marble Onix | 18.182 | 102 |
| Marble Emperador Gold | 18.183 | 92 |
| Marble Rainforest | 18.184 | 101 |
| Lacquered Metal | 18.185 | 98 |
| Brass | 18.186 | 124 |
| Walnut | 18.187 | 96 |
| Ash Burl | 18.188 | 99 |

| Top | Ref | Points |
|-----------------------|--------|------------|
| Marble Negro Intenso | 18.191 | 88 |
| Marble Onix | 18.192 | 87 |
| Marble Emperador Gold | 18.193 | 82 |
| Marble Rainforest | 18.194 | 87 |
| Lacquered Metal | 18.195 | 87 |
| Brass | 18.196 | 106 |
| Walnut | 18.197 | 86 |
| Ash Burl | 18.198 | 89 |

TWIN ARRIMADERAS / ARRIMADERAS TWIN

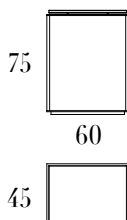
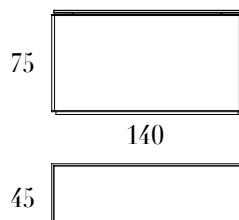

| Top | Ref | Points |
|-----------------------|--------|------------|
| Marble Negro Intenso | 18.201 | 296 |
| Marble Onix | 18.202 | 283 |
| Marble Emperador Gold | 18.203 | 233 |
| Marble Rainforest | 18.204 | 276 |
| Lacquered Metal | 18.205 | 236 |
| Brass | 18.206 | 384 |
| Walnut | 18.207 | 216 |
| Ash Burl | 18.208 | 224 |

| Top | Ref | Points |
|-----------------------|--------|------------|
| Marble Negro Intenso | 18.211 | 165 |
| Marble Onix | 18.212 | 159 |
| Marble Emperador Gold | 18.213 | 134 |
| Marble Rainforest | 18.214 | 156 |
| Lacquered Metal | 18.215 | 143 |
| Brass | 18.216 | 205 |
| Walnut | 18.217 | 134 |
| Ash Burl | 18.218 | 138 |

TWIN CONSOLES / CONSOLAS TWIN / CONSOLES TWIN

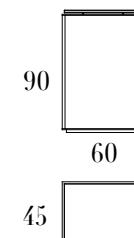
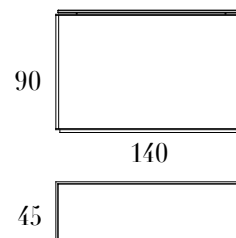

| Top | Ref | Points |
|-----------------------|--------|------------|
| Marble Negro Intenso | 18.221 | 309 |
| Marble Onix | 18.222 | 296 |
| Marble Emperador Gold | 18.223 | 246 |
| Marble Rainforest | 18.224 | 289 |
| Lacquered Metal | 18.225 | 249 |
| Brass | 18.226 | 397 |
| Walnut | 18.227 | 229 |
| Ash Burl | 18.228 | 237 |

| Top | Ref | Points |
|-----------------------|--------|------------|
| Marble Negro Intenso | 18.231 | 176 |
| Marble Onix | 18.232 | 170 |
| Marble Emperador Gold | 18.233 | 145 |
| Marble Rainforest | 18.234 | 167 |
| Lacquered Metal | 18.235 | 154 |
| Brass | 18.236 | 216 |
| Walnut | 18.237 | 145 |
| Ash Burl | 18.238 | 149 |

Structures always be lacquered
Las estructuras siempre irán lacadas
Structures toujours laqués

/ Marble top thickness 2 cm
/ Tapas de mármol grosor 2 cm
/ Plateaux marbre épaisseur 2 cm

SHELVES ALEJANDRÍA 128 cm / ESTANTERÍAS ALEJANDRÍA 128 cm / ETAGERES ALEJANDRIA 128 cm

Shelving Units 128cm
Estantería 128cm
Etageres 128cm

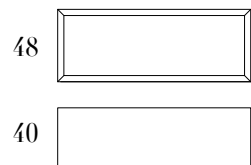

| Finish | Ref | Points Brass |
|---------|--------|--------------|
| Walnut | 18.070 | 120 |
| Lacquer | 18.071 | 120 |

Base 128 cm
Zócalo 128cm
Socle 128 cm

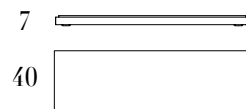

| Finish | Ref | Points Brass |
|---------|--------|--------------|
| Walnut | 18.072 | 112 |
| Lacquer | 18.073 | 112 |

Shelves between Modules 128 cm
Estante entre Módulos 128cm
Etageres entre Modules

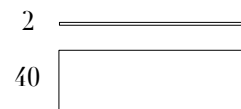

| Finish | Ref | Points Brass |
|---------|--------|--------------|
| Walnut | 18.074 | 12 |
| Lacquer | 18.075 | 12 |

Divider between shelving units
Divisorias para Estanterías
Divisoire pour Etageres
128 cm and 64 cm

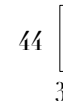

| Finish | Ref | Points Brass |
|---------|--------|--------------|
| Walnut | 18.076 | 7 |
| Lacquer | 18.077 | 7 |

ACCESORIES FOR SHELVES 128 cm / COMPLEMENTOS PARA ESTANTERÍAS 128 cm / COMPLÉMENTS POUR ETAGERES DE 128 cm

Module 1 Drawer
Módulo 1 Cajón
Module Tiroir

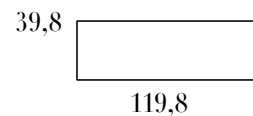

| Finish | Ref | Points Brass |
|----------|--------|--------------|
| Walnut | 18.086 | 120 |
| Ash Burl | 18.087 | 136 |
| Lacquer | 18.088 | 120 |

Module Drawer with Interior Drawer
Módulo 1 Cajón con Cajón Interior
Module Tiroir avec Tiroir Interieur

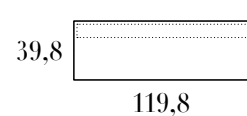

| Finish | Ref | Points Brass |
|----------|--------|--------------|
| Walnut | 18.089 | 145 |
| Ash Burl | 18.090 | 161 |
| Lacquer | 18.091 | 145 |

Wooden Trapdoor
Trampón Madera
Porte Abattante Bois

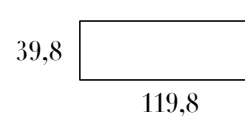

| Finish | Ref | Points Brass |
|----------|--------|--------------|
| Walnut | 18.092 | 118 |
| Ash Burl | 18.093 | 142 |
| Lacquer | 18.094 | 118 |

Glass Trapdoor
Trampón Cristal
Porte Abattante Verre

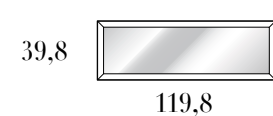

| Finish | Ref | Points Brass |
|---------|--------|--------------|
| Walnut | 18.095 | 126 |
| Lacquer | 18.096 | 126 |

SHELVES ALEJANDRÍA 64 cm / ESTANTERÍAS ALEJANDRÍA 64 cm / ETAGERES ALEJANDRIA 64 cm

Shelving unit 64 cm
Estantería 64 cm
Etageres 64 cm

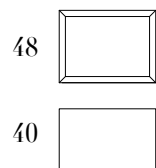

| Finish | Ref | Points Brass |
|---------|--------|--------------|
| Walnut | 18.080 | 86 |
| Lacquer | 18.081 | 86 |

Base 64 cm
Zócalo 64 cm
Socle 64 cm

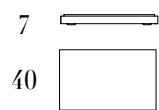

| Finish | Ref | Points Brass |
|---------|--------|--------------|
| Walnut | 18.082 | 88 |
| Lacquer | 18.083 | 88 |

Shelves between Modules 64 cm
Estante entre Módulos 64 cm
Etageres entre Modules 64 cm

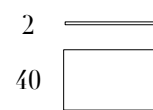

| Finish | Ref | Points Brass |
|---------|--------|--------------|
| Walnut | 18.084 | 8 |
| Lacquer | 18.085 | 8 |

Divider between shelving units
Divisorias para Estanterías
Divisoire pour Etageres
128 cm and 64 cm

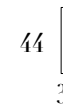

| Finish | Ref | Points Brass |
|---------|--------|--------------|
| Walnut | 18.076 | 7 |
| Lacquer | 18.077 | 7 |

ACCESORIES FOR SHELVES 64 cm / COMPLEMENTOS PARA ESTANTERÍAS 64 cm / COMPLÉMENTS POUR ETAGERES DE 64 cm

Module 1 Drawer
Módulo 1 Cajón
Module Tiroir

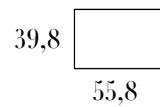

| Finish | Ref | Points Brass |
|----------|--------|--------------|
| Walnut | 18.303 | 96 |
| Ash Burl | 18.304 | 112 |
| Lacquer | 18.305 | 96 |

Module Drawer with Interior Drawer
Módulo 1 Cajón con Cajón Interior
Module Tiroir avec Tiroir Interieur

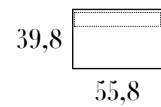

| Finish | Ref | Points Brass |
|----------|--------|--------------|
| Walnut | 18.306 | 121 |
| Ash Burl | 18.307 | 137 |
| Lacquer | 18.308 | 121 |

Wooden Trapdoor
Trampón Madera
Porte Abattante Bois

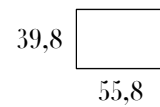

| Finish | Ref | Points Brass |
|----------|--------|--------------|
| Walnut | 18.309 | 94 |
| Ash Burl | 18.310 | 118 |
| Lacquer | 18.311 | 94 |

Glass Trapdoor
Trampón Cristal
Porte Abattante Verre

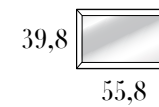

| Finish | Ref | Points Brass |
|---------|--------|--------------|
| Walnut | 18.312 | 102 |
| Lacquer | 18.313 | 102 |

VISO SOFAS / SOFÁS VISO / CANAPÉ VISO

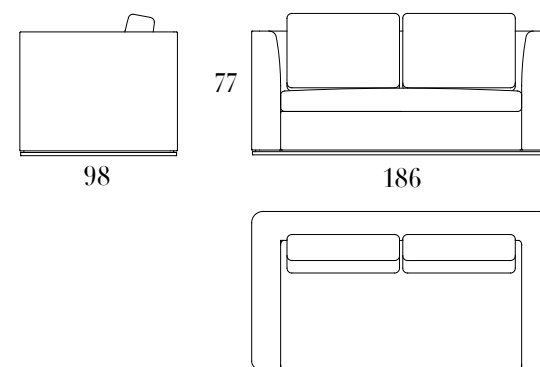
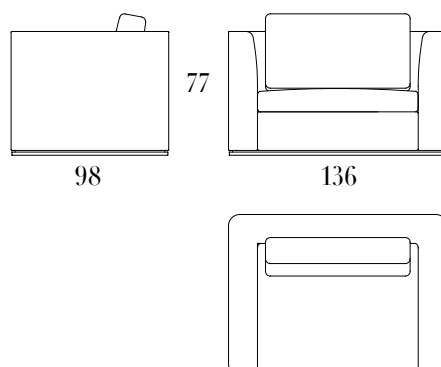
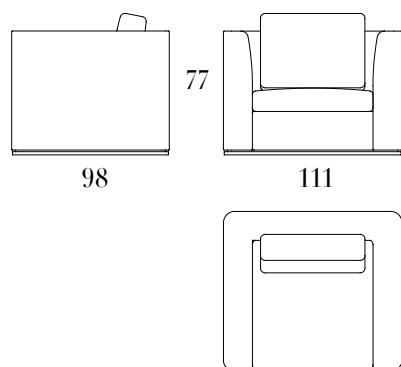

| Upholstered / Tapizado / Tapissé | Ref | Points |
|----------------------------------|-----------|--------|
| C.O.M. | 18.120/TC | 282 |
| Fabric B | 18.120/B | 357 |
| Fabric C | 18.120/C | 387 |
| Fabric D | 18.120/D | 433 |
| Fabric E | 18.120/E | 524 |
| Fabric F | 18.120/F | 710 |
| Fabric G | 18.120/G | 938 |
| Leather 1 | 18.120/P1 | 534 |
| Leather 2 | 18.120/P2 | 635 |
| Leather Special | 18.120/PE | 772 |

| | |
|---------------------------------------|------|
| Brass Plinth | +68 |
| Diamond Stiching Option | +50 |
| Sides and Back Parts in Walnut Veneer | +139 |
| Sides and Back Parts in Ash Burl | +198 |

Fabric Required: 10,90 m Fabric Width 1,40 m
19,80 m² Leather

| Upholstered / Tapizado / Tapissé | Ref | Points |
|----------------------------------|-----------|--------|
| C.O.M. | 18.129/TC | 298 |
| Fabric B | 18.129/B | 375 |
| Fabric C | 18.129/C | 406 |
| Fabric D | 18.129/D | 453 |
| Fabric E | 18.129/E | 546 |
| Fabric F | 18.129/F | 738 |
| Fabric G | 18.129/G | 972 |
| Leather 1 | 18.129/P1 | 558 |
| Leather 2 | 18.129/P2 | 662 |
| Leather Special | 18.129/PE | 804 |

| | |
|---------------------------------------|------|
| Brass Plinth | +75 |
| Diamond Stiching Option | +53 |
| Sides and Back Parts in Walnut Veneer | +155 |
| Sides and Back Parts in Ash Burl | +219 |

Fabric Required: 11,20 m Fabric Width 1,40 m
20 m² Leather

| Upholstered / Tapizado / Tapissé | Ref | Points |
|----------------------------------|-----------|--------|
| C.O.M. | 18.130/TC | 358 |
| Fabric B | 18.130/B | 472 |
| Fabric C | 18.130/C | 518 |
| Fabric D | 18.130/D | 587 |
| Fabric E | 18.130/E | 724 |
| Fabric F | 18.130/F | 1.007 |
| Fabric G | 18.130/G | 1.351 |
| Leather 1 | 18.130/P1 | 691 |
| Leather 2 | 18.130/P2 | 886 |
| Leather Special | 18.130/PE | 1.095 |

| | |
|---------------------------------------|------|
| Brass Plinth | +85 |
| Diamond Stiching Option | +60 |
| Sides and Back Parts in Walnut Veneer | +178 |
| Sides and Back Parts in Ash Burl | +252 |

Fabric Required: 16,50 m Fabric Width 1,40 m
30 m² Leather

VISO SOFAS / SOFÁS VISO / CANAPÉ VISO

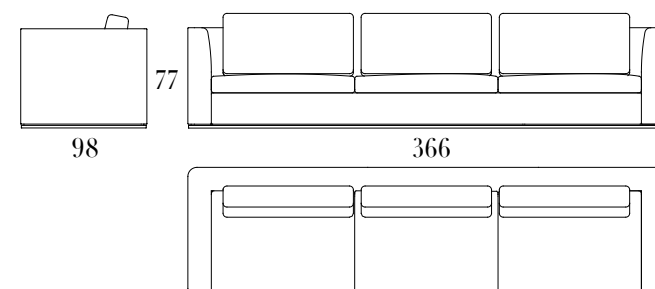
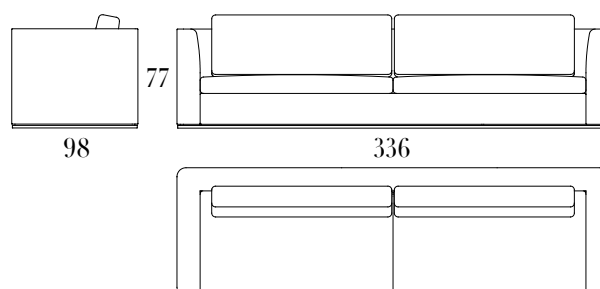
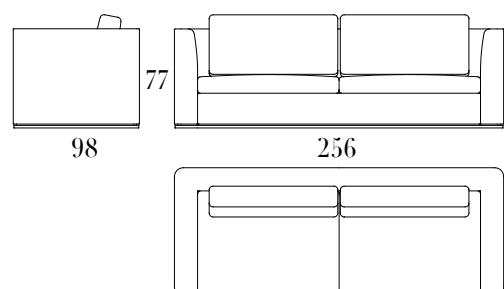

| Upholstered / Tapizado / Tapissé | Ref | Points |
|----------------------------------|-----------|--------|
| C.O.M. | 18.139/TC | 421 |
| Fabric B | 18.139/B | 535 |
| Fabric C | 18.139/C | 581 |
| Fabric D | 18.139/D | 650 |
| Fabric E | 18.139/E | 787 |
| Fabric F | 18.139/F | 1.070 |
| Fabric G | 18.139/G | 1.414 |
| Leather 1 | 18.139/P1 | 754 |
| Leather 2 | 18.139/P2 | 1.102 |
| Leather Special | 18.139/PE | 1.115 |

| | |
|---------------------------------------|------|
| Brass Plinth | +94 |
| Diamond Sticking Option | +72 |
| Sides and Back Parts in Walnut Veneer | +211 |
| Sides and Back Parts in Ash Burl | +298 |

Fabric Required: 16,50 m Fabric Width 1,40 m
30 m² Leather

| Upholstered / Tapizado / Tapissé | Ref | Points |
|----------------------------------|-----------|--------|
| C.O.M. | 18.140/TC | 466 |
| Fabric B | 18.140/B | 624 |
| Fabric C | 18.140/C | 687 |
| Fabric D | 18.140/D | 782 |
| Fabric E | 18.140/E | 972 |
| Fabric F | 18.140/F | 1.363 |
| Fabric G | 18.140/G | 1.838 |
| Leather 1 | 18.140/P1 | 984 |
| Leather 2 | 18.140/P2 | 1.130 |
| Leather Special | 18.140/PE | 1.484 |

| | |
|---------------------------------------|------|
| Brass Plinth | +118 |
| Diamond Sticking Option | +82 |
| Sides and Back Parts in Walnut Veneer | +248 |
| Sides and Back Parts in Ash Burl | +349 |

Fabric Required: 22,80 m Fabric Width 1,40 m
41 m² Leather

| Upholstered / Tapizado / Tapissé | Ref | Points |
|----------------------------------|-----------|--------|
| C.O.M. | 18.149/TC | 483 |
| Fabric B | 18.149/B | 641 |
| Fabric C | 18.149/C | 704 |
| Fabric D | 18.149/D | 799 |
| Fabric E | 18.149/E | 989 |
| Fabric F | 18.149/F | 1.380 |
| Fabric G | 18.149/G | 1.855 |
| Leather 1 | 18.149/P1 | 1.005 |
| Leather 2 | 18.149/P2 | 1.155 |
| Leather Special | 18.149/PE | 1.503 |

| | |
|---------------------------------------|------|
| Brass Plinth | +124 |
| Diamond Sticking Option | +90 |
| Sides and Back Parts in Walnut Veneer | +261 |
| Sides and Back Parts in Ash Burl | +369 |

Fabric Required: 22,80 m Fabric Width 1,40 m
41 m² Leather

CUSHIONS / COJINES / COUSSINS

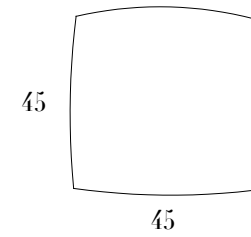
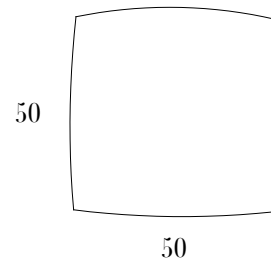
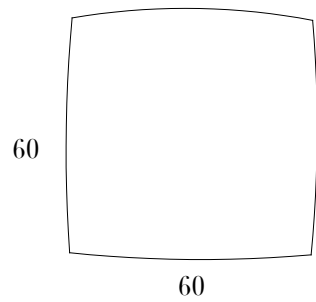

| Upholstered / Tapizado / Tapissé | Ref | Points |
|----------------------------------|-----------|--------|
| C.O.M. | 18.150/TC | 12 |
| Fabric B | 18.150/B | 16 |
| Fabric C | 18.150/C | 18 |
| Fabric D | 18.150/D | 21 |
| Fabric E | 18.150/E | 26 |
| Fabric F | 18.150/F | 37 |
| Fabric G | 18.150/G | 51 |
| Leather 1 | 18.150/P1 | 26 |
| Leather 2 | 18.150/P2 | 33 |
| Leather Special | 18.150/PE | 41 |

Fabric Required: 0,65 m Fabric Width 1,40 m
1,25 m² Leather

| Upholstered / Tapizado / Tapissé | Ref | Points |
|----------------------------------|-----------|--------|
| C.O.M. | 18.159/TC | 9 |
| Fabric B | 18.159/B | 13 |
| Fabric C | 18.159/C | 14 |
| Fabric D | 18.159/D | 17 |
| Fabric E | 18.159/E | 21 |
| Fabric F | 18.159/F | 31 |
| Fabric G | 18.159/G | 42 |
| Leather 1 | 18.159/P1 | 19 |
| Leather 2 | 18.159/P2 | 24 |
| Leather Special | 18.159/PE | 31 |

Fabric Required: 0,55 m Fabric Width 1,40 m
0,99 m² Leather

| Upholstered / Tapizado / Tapissé | Ref | Points |
|----------------------------------|-----------|--------|
| C.O.M. | 18.160/TC | 8 |
| Fabric B | 18.160/B | 11 |
| Fabric C | 18.160/C | 13 |
| Fabric D | 18.160/D | 15 |
| Fabric E | 18.160/E | 19 |
| Fabric F | 18.160/F | 27 |
| Fabric G | 18.160/G | 38 |
| Leather 1 | 18.160/P1 | 17 |
| Leather 2 | 18.160/P2 | 20 |
| Leather Special | 18.160/PE | 26 |

Fabric Required: 0,50 m Fabric Width 1,40 m
0,78 m² Leather

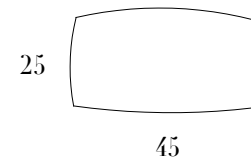
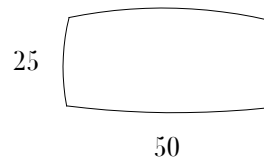
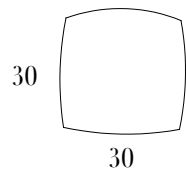

| Upholstered / Tapizado / Tapissé | Ref | Points |
|----------------------------------|-----------|--------|
| C.O.M. | 18.169/TC | 7 |
| Fabric B | 18.169/B | 9 |
| Fabric C | 18.169/C | 10 |
| Fabric D | 18.169/D | 12 |
| Fabric E | 18.169/E | 15 |
| Fabric F | 18.169/F | 21 |
| Fabric G | 18.169/G | 28 |
| Leather 1 | 18.169/P1 | 12 |
| Leather 2 | 18.169/P2 | 14 |
| Leather Special | 18.169/PE | 17 |

Fabric Required: 0,35 m Fabric Width 1,40 m
0,42 m² Leather

| Upholstered / Tapizado / Tapissé | Ref | Points |
|----------------------------------|-----------|--------|
| C.O.M. | 18.170/TC | 8 |
| Fabric B | 18.170/B | 10 |
| Fabric C | 18.170/C | 11 |
| Fabric D | 18.170/D | 12 |
| Fabric E | 18.170/E | 15 |
| Fabric F | 18.170/F | 20 |
| Fabric G | 18.170/G | 26 |
| Leather 1 | 18.170/P1 | 14 |
| Leather 2 | 18.170/P2 | 17 |
| Leather Special | 18.170/PE | 21 |

Fabric Required: 0,30 m Fabric Width 1,40 m
0,54 m² Leather

| Upholstered / Tapizado / Tapissé | Ref | Points |
|----------------------------------|-----------|--------|
| C.O.M. | 18.179/TC | 8 |
| Fabric B | 18.179/B | 10 |
| Fabric C | 18.179/C | 11 |
| Fabric D | 18.179/D | 12 |
| Fabric E | 18.179/E | 15 |
| Fabric F | 18.179/F | 20 |
| Fabric G | 18.179/G | 26 |
| Leather 1 | 18.179/P1 | 14 |
| Leather 2 | 18.179/P2 | 17 |
| Leather Special | 18.179/PE | 21 |

Fabric Required: 0,30 m Fabric Width 1,40 m
0,50 m² Leather

CEILING LAMP ETOILE / LÁMPARA TECHO / LAMPE

Big Lamp / Lámpara Grande / Lampe Grand

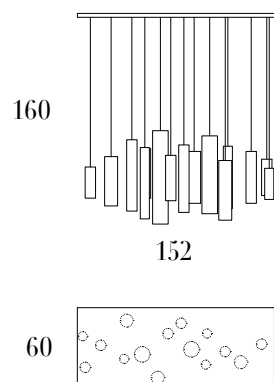

60 Kg / Max 60 Watts

| Finish | Ref | Points |
|--------|--------|------------|
| Latón | 18.069 | 583 |

Suitable for 3 meters high ceiling
Aconsejada para altura de techo 3 m

Small Lamp / Lámpara Pequeña / Lampe Petite

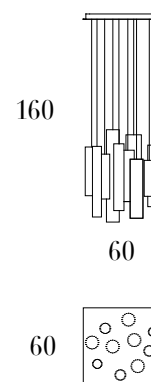

45 Kg / Max 60 Watts

| Finish | Ref | Points |
|--------|--------|------------|
| Latón | 18.107 | 453 |

Suitable for 3 meters high ceiling
Aconsejada para altura de techo 3 m

THE
ILAND
COLLECTION

by Fermín Verdeguer

MOBILFRESNO

Ctra. de Villena, km. 2,5 P.O. Box 119
T: +34 968 751 011 F: +34 968 751 588
30510 Yecla, Murcia - Spain
mobilfresno@mobilfresno.com
www.mobilfresno.com

Impresión: 15 de Enero de 2014

V 1